

eQ Lift Table Lite-R

Ergonomischer Bürotisch mit gerundeten Ecken, runden Säulen und stufenloser Höhenverstellung. Gefertigt in der Schweiz, überzeugt der eQ Lift Table Lite-R von Embru mit höchster Qualität und Langlebigkeit. Wählen Sie aus vielfältigen Materialien, Farben und Zubehör für Ihre individuelle Konfiguration. Funktionalität und Design – perfekt auf Ihre Bedürfnisse abgestimmt.

 SEIT 1904
SCHWEIZER
MÖBELHERSTELLER



 **paul morger**
BÜROCENTER

Paul Morger AG | Rapperswilerstrasse 59 | 8630 Rüti ZH
Tel. 055 251 20 20 | info@morger.ch | www.morger.ch

embru

Standardausführung

Produkt	Elektrische Höhenverstellung Tischplattenraster Breite Tischplattenraster Tiefe Gesteuerte Antikollision Belastbarkeit	65 – 130 cm, 2-fach Teleskop 80 / 100 / 120 / 140 / 160 / 180 / 200 cm 80 / 90 / 100 cm Grundausrüstung max. 70 kg inkl. Tischplatte
Materialisierung	Farbe der Liftsäule Farbe Gestell Ausleger / Füsse	schwarz / anthrazit / Alu metallisé / weiss pulverbeschichtet gemäss Kollektion Rechteckfuss pulverbeschichtet, glanz- und mattverchromt
Ausstattung	Desk-Panel für Höhenverstellung Höhenverstellung Schiebepatte mit fixer Kabelwanne Festplatte abklappbare Kabelwanne	wahlweise 2er-Taster auf/ab oder 4-fach Memory-Funktion mit digitaler Höhenanzeige wahlweise mit / ohne wahlweise
Zubehör	Bedientaster gross Bedientaster klein Bildschirmhalter Beinraumbende Kabelkette Stiftebehälter Handyhalter Papierablage A4 Steckdosenleiste Box A4 Lampe	

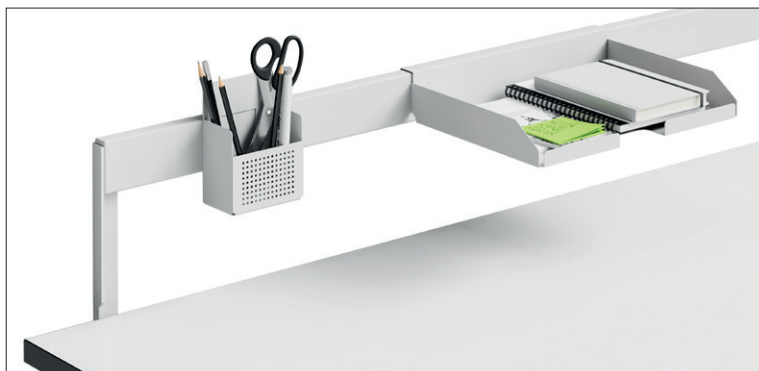

Vermassungen

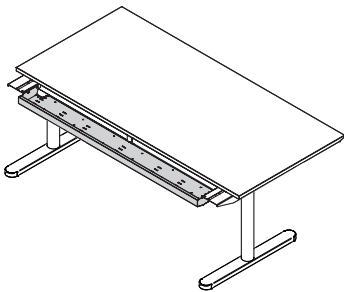
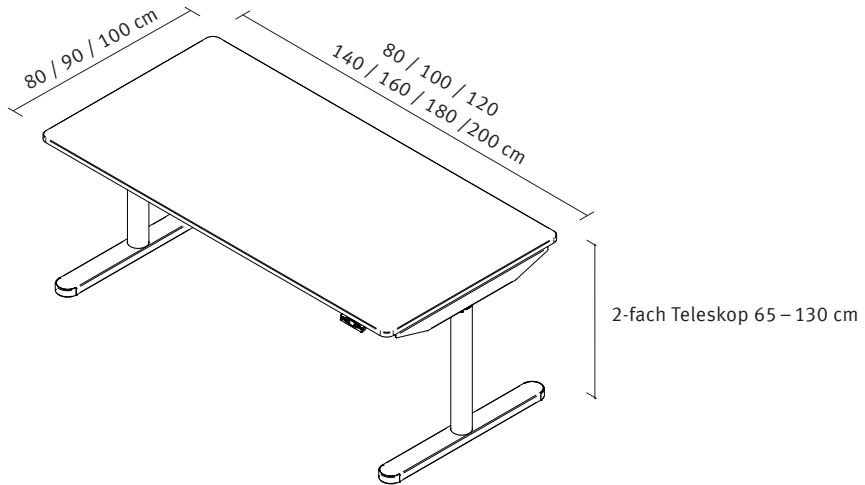

Kabelwanne fix

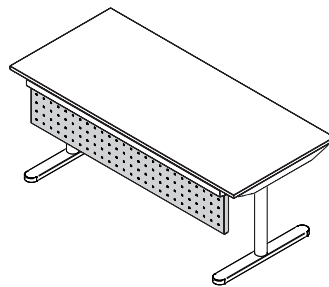

Rückwand

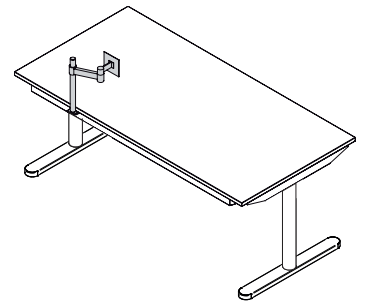

Flachbildschirmträger

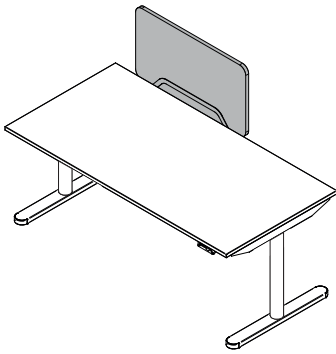

Akustik Panel Filz

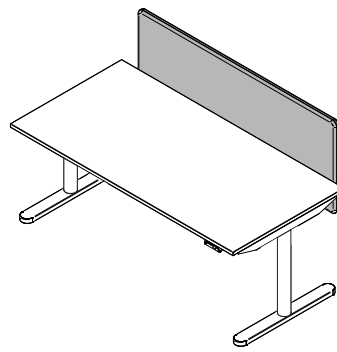

Privacy Panel Textil

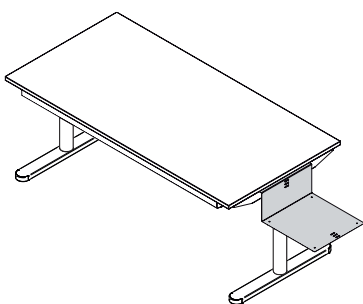

Druckertablar

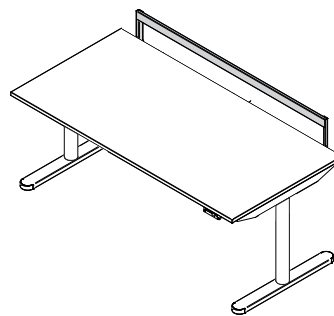

















Funktionschiene für Zubehör









CPU-Träger seitlich innen

eQ Oberflächen Module und Tischgestelle



Seidenglanzfarben

				
Verkehrswiss* RAL 9016	Weissgrün NCS 1015 G80Y	Lichtblau NCS 2010 R80B	Enzianblau RAL 5010	Stahlblau RAL 5011
				
Karminrot RAL 3002	Rotorange RAL 2001	Goldgelb RAL 1004	Gelbgrün RAL 6018	Lichtgrau RAL 7035
				
Staubgrau RAL 7037	Graubraun RAL 8019	Tiefschwarz* RAL 9005	Anthrazit metallisé* B1	Schwarz metallisé B2
		* Säulenfarben für höhenverstellbare Tische		
Alu metallisé silber* B3	Grau metallisé GM			

Matte Softtouchfarben



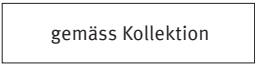



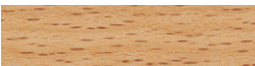

				
Samtweiss Trend 8	Sandbeige Design 12	Polarblau Design 17	Lavarot Design 15	Goldkastanie Style 26
				
Quarzgrau Classic 37	Basaltschwarz Trend 9			

Seitenprofile, Griffe und Fussausleger

			* ausgenommen Airdesk
Pulverbeschichtet	Alu matt / mattverchromt*	Glanzverchromt*	

eQ Oberflächen Tisch- und Abschlussplatten

Furniere

				
Buche gedämpft	Europäischer Ahorn	Europäischer Ahorn weisslich lasiert	Eiche	Eiche weisslich lasiert
				
Black Cherry	Amerikanischer Nussbaum	Esche schwarz lackiert		

Kunstharzbelag

HPL Argolite

Linoleum Desktop

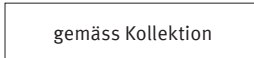

Kanten

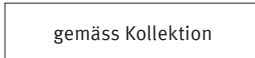

ABS schwarz